

Conductivity Meter Type M3136

OPERATING MANUAL



Warranty:

Mostec warrants this product to be free of manufacturing defects for a 2-year period after the original date of purchase. Within this period, defective products will be repaired free of charge provided that the defect occurred during normal operation. This warranty does not cover damage to the product resulting from ordinary usage such as front panel scratches, broken control elements and corrosion, etc. The customer is responsible for shipping and packing charges for products returned under warranty to Mostec. Mostec warrants this product beyond the 2-year warranty period for an additional 2 years in case of long term damages due to improper manufacturing. Such damages as poorly soldered joints or other assembly problems are also covered by the warranty. Transportation damages are not covered by the warranty and should be referred to the respective delivery service.

Technical data

The M3136 conductivity meter is suitable for water, waste water or pure water conditioning in continuous or batch-type operating modes, for liquid chromatography or for general chemical process monitoring.

Temperature coefficient of the cell is compensated either manually or automatically by an external Pt-100 platinum probe within the range of 0°C to 120°C.

Commercially available conductivity cells K-factor is 0.01, 0.1, 1.0 and 10 cover a dynamic range from 0.01 μ S to 20mS full scale. An internal synchronous rectifier eliminates the capacitive error currents induced by the cell cable.

The ranges conductivity and temperature have an optional signal current output of 0...20mA. An external 24V-signal switches the output to conductivity or temperature.

Two floating limit or alarm contacts can be set over the entire range. Each is defined as a normally open or as a normally closed contact.

Supply lines and all other lines, either from or to the conductivity meter, are protected by internal noise limiters against HF-noise.

Power supply: Universal supply 20 to 253VAC/DC

Index	Page
1. Safety Instructions.....	4
2. Operating Regulations.....	4
3. Front Panel Controls	5
4. Display Screen	5
5. User Menu	6
5.1. Operating the user menu	7
5.2. Measure Settings.....	7
5.3. Device Settings.....	8
5.4. Relay Settings.....	8
5.4.1. Relay 1 & 2.....	8
5.4.2. Set-Point optical.....	9
5.5. USB Settings	10
5.5.1. USB Characteristics.....	10
5.5.2. Data Format.....	11
5.6. Modbus Settings	11
5.7. Device info.....	11
6. Modbus-RS485	12
7. Wiring.....	12
8. Terminals	12
9. Technical Data	13

1. Safety Instructions



Observe the local regulations and safety regulations for electrical, low-voltage and high-voltage systems.



Please read this document carefully before using this product.



The device must be protected against inadmissible humidity, vibrations and severe soiling.



During an installation, all off the cables that are connected to the device must be free of electrical power.



The limit values for the measured quantities specified in the specification must not be exceeded under any circumstances.



The wiring, commissioning and operation of the devices must be carried out by appropriately qualified personnel in accordance with local regulations.



If it is to be assumed that the device can no longer be operated safely, it must be put out of operation and secured by means of identification before further commissioning.



Failure to observe the safety instructions may result in damage to the device and injury to the operator.

2. Operating Regulations

1. Connect the device according to the wiring diagram.
2. Connect the conductivity probe.
3. After everything has been correctly connected, turn on the system power.
4. Press **[ENT]** and **[ESC]** simultaneously for about 1 second to open the customer menu to set the cell K-factor and the range in the measurement menu.
5. Set the temperature compensation and all other required settings as needed.

3. Front Panel Controls

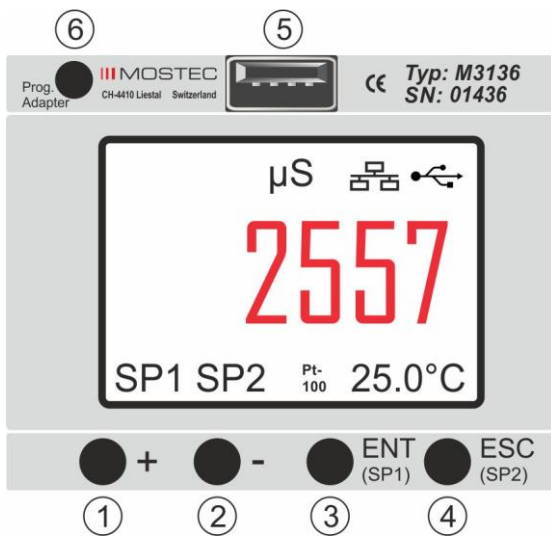

1. Key **[+]**
2. Key **[-]**
3. Key **[ENT]** / SP1
4. Key **[ESC]** / SP2
5. USB socket type A for logging data (optional)
6. Interface for MOSTEC programming adapter.

4. Display Screen

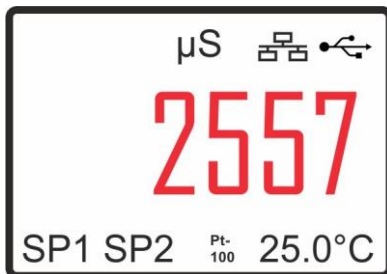

After the startup process, the display switches to measuring mode.

The main screen displays the most important information such as the current conductivity value, the actual temperature value and the status of the limit values. The Pt100 or hand symbol indicates whether the temperature is measured via an external Pt100 platinum probe or it was set manually.

The icons for USB and Modbus shows the status of the peripherals.

5. User Menu

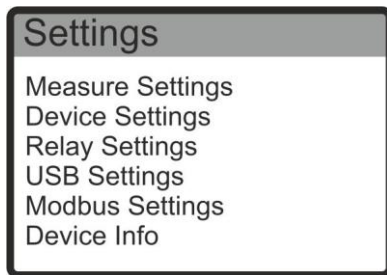

The user menu is divided into different submenus. In these, device-specific manipulations can be made.

To enter the menu, press **[ENT]** and **[ESC]** simultaneously for about 1 second.

Menu item	Submenu items	Section
Measure Settings Messeinstellungen	Set cell K-factor Set range Adjust correction factor Switch temp. Manual / Pt100 Set temperature Adjust temperature slope Adjust output min. value Adjust output max. value	5.2. Measure Settings
Device Settings Geräteeinstellungen	Select language Activate locking code Adjust backlight Factory settings	5.3. Device Settings
Relay Settings Grenzwerteinstellungen	Relay 1 & 2: Set set-point Setting the hysteresis Setting the logic of the relays LED adjustment Set-point optical: Set display value Set limit value active Set set-point	5.4. Relay Settings 5.4.1. Relay 1 & 2 5.4.2. Set-Point optical
USB Settings USB Einstellungen	Set log interval Setting the time Setting the date Exit log	5.5. USB Settings
Modbus Settings Modbus Einstellungen	Available soon!	5.6. Modbus Settings
Device Info Geräteinfo	Firmware version Serial number	5.7. Device Info

5.1. Operating the user menu



The menu is operated with the keys **[ENT]**, **[ESC]**, **[+]** and **[-]**. Use **[+]** and **[-]** to navigate through the menu items. Press **[ENT]** to enter the respective submenu and press **[ESC]** to exit the submenu. In the submenu you can navigate through the individual points with **[+]** and **[-]**. Press **[ENT]** to activate the parameters which can be changed with **[+]** and **[-]**. Pressing **[ENT]** saves the value, **[ESC]** discards the changes.

5.2. Measure Settings

The menu is operated with the keys **[ENT]**, **[ESC]**, **[+]** and **[-]**. Settings can be made as described in section 5.1. Operating the user menu.

Measure Settings	
Cell K-factor:	1.00
Range:	2mS
Correction Factor:	1.000
Manual/Pt100:	Manual
Set Temperature:	25.0
< 1/2 >	

Measure Settings	
Temp. Slope:	2.25
Output Min.:	0.00
Output Max.:	20.00
< 2/2 >	

Menu item	Function/comment	Possible values
Cell K-Factor Zellkonstante	Set cell K-factor	- 0.01 - 0.10 - 1.00 - 10.0
Range Bereich	Set measurement range	- 0...2.000µS - 0...20.00µS - 0...200.0µS - 0...2.000mS - 0...20.00mS - 0...200.0mS
Correction Factor Korrekturfaktor	Fine-adjustment of the correction factor	Adjustable from 0.000 to 2.000
Manual / Pt100 Temp. Hand/Pt100	Switch the temperature between Pt100 and manual	- Manual  - Pt100 probe 
Set Temperature Temp. einstellen	Fine-adjustment of the manual temperature	Adjustable from 0.0°C to 90.0°C
Temp. Slope Steilheit Temp.	Fine-adjustment of the temperature slope	Adjustable from 0.00%/°C (off) to 8.00%/°C
Output Min. Ausgang Min.	Fine-adjustment of the minimum signal output.	Adjustable from 0.00mA to 21.00mA
Output Max. Ausgang Max.	Fine-adjustment of the maximum signal output.	Adjustable from 0.00mA to 21.00mA

5.3. Device Settings

Device Settings	
Language:	GER
Code:	Off
Backlight:	50 %
Factory Reset	No

The menu is operated with the keys **[ENT]**, **[ESC]**, **[+]** and **[-]**. Settings can be made as described in section 5.1. **Operating the user menu.**

Menu item	Function/Comment	Possible values
Language Sprache	Set the user language	- GER (Deutsch) - ENG (English) - FRA (Français)
Code Sperrcode	Set a lock code for the menu to prevent manipulation of the settings. It is still possible to view all menu items.	- 4-digit from 0001 bis 9999 - 0000 => no code (=factory) Note: Please contact us if you miss the code
Backlight Helligkeit	Set the display brightness	Adjustable from 5% to 100%. Attention: 100% brightness leads to faster LED wear!
Factory Reset Gerät zurücksetzen	Reset all settings of the device to factory values	Set to "Yes" and confirm with [ENT] .

5.4. Relay Settings

Relay Settings	
Relay 1	
Relay 2	
Set-Point Optical	

The two potential-free changeover contacts and the optical limit value can be configured in the **Relay Settings** submenu. Use the **[+]** and **[-]** keys to navigate through the limit values. Press **[ENT]** to access the submenu of the respective limit value and press **[ESC]** to exit the submenu.

5.4.1. Relay 1 & 2

Relay 1	
Set-Point:	250
Hysteresis:	10
Behavior:	norm.
LED:	norm.

The menu is operated with the keys **[ENT]**, **[ESC]**, **[+]** and **[-]**. Settings can be made as described in section 5.1. **Operating the user menu.**

Menu item	Function/comment	Possible values
Set-Point Sollwert	Set the set-point of relay 1 or 2	Between display min. and max. adjustable (= range)
Hysteresis Hysterese	Setting the hysteresis of relay 1 or 2	Adjustable between 0 and half range
Behavior Verhalten	Set the logic of relay 1 or 2	<ul style="list-style-type: none"> - Normal (relay is activated when the measured value is higher than the set-point) - Inverted (relay is activated when the measured value is lower than the set-point)
LED LED	Set the logic of the LEDs	<ul style="list-style-type: none"> - Normal (display when the measured value is higher than the set-point) - Inverted (display when the measured value is lower than the set-point)

5.4.2. Set-Point optical

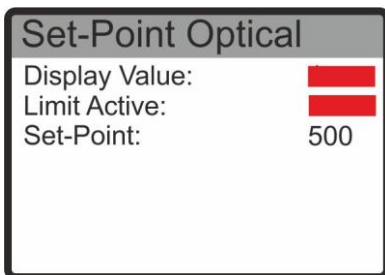

The menu is operated with the keys **[ENT]**, **[ESC]**, **[+]** and **[-]**. Settings can be made as described in section 5.1. **Operating the user menu.**

Menu item	Function/comment	Possible values
Display Value Anzeigewert	Display color of the measured value	Various colors selectable in the menu
Limit Active Grenzwert aktiv.	Display color of the measured value with activated limit	Various colors selectable in the menu
Set-point Sollwert	Set-point of the optical limit value	Between display min. and max. adjustable (= range)

5.5. USB Settings

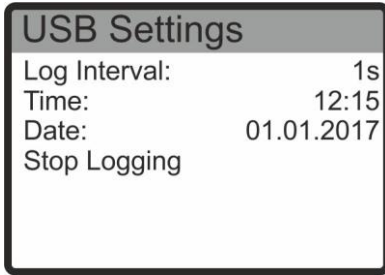

The menu is operated with the keys [ENT], [ESC], [+] and [-]. Settings can be made as described in section 5.1. **Operating the user menu.**

Menu item	Function/comment	Possible values
Log Interval Log Intervall	Set the storage interval of the USB logger	Adjustable from 1s to 7200s (2h)
Time Zeit	Set the current time for the USB logger (time is stored for 3 hours in case of power failure)	- Hours: 0...23 - Minutes: 0...59 - Seconds are set to 0 when setting the minutes
Date Datum	Set the current date for the USB logger (date is saved for 3 hours in case of power failure)	- Day: 1...31 - Month: 1...12 - Year: 2010...2099
Stop / Start Logging Log beenden / starten	Terminates the log and saves the log file on the USB storage medium with time and date / Starts the logging	Press [ENT] to confirm

5.5.1. USB Characteristics

- The device only accepts USB sticks which are FAT32 formatted and empty.
- The time and date must be set before switching on the recording function. These settings remain in the de-energized state (power failure) for a period of < 3h. After this period, the date and time must be adjusted.
- In the menu item **Log Interval** you can set the interval time in which the data are recorded.
- As soon as a valid storage medium is detected by the device, the USB symbol appears on the display and the logging process starts.
- The data is written to the USB stick every 30s, if **Log Interval** < 30s. Otherwise, after the **Log interval** has expired. While writing to the USB stick, the USB symbol is displayed in red. **Meanwhile, the USB stick must not be removed!**
- If a USB stick is connected, the menu item **Exit logging** appears. Confirm with [ENT] to end the logging process. The menu item changes to **Start logging**. Confirm with [ENT] to restart the logging process and the logger will create a new file on the USB stick.
→ If no USB stick is connected, this menu item is not displayed.

5.5.2. Data Format

The data is saved in CSV format under the following name key:

„JJMMDDXX.csv“

- JJ = last 2 digit of current year (z.B. 2018 = „18“)
- MM = current month
- DD = current day
- XX = file counter (0-99)

The CSV format can be interpreted with common spreadsheet programs:

Date	Time	Conductivity	Temperature
12.12.2017	13:10:45	55.5uS	25.2°C
12.12.2017	13:10:46	55.5uS	25.2°C
12.12.2017	13:10:47	55.5uS	25.2°C

5.6. Modbus Settings

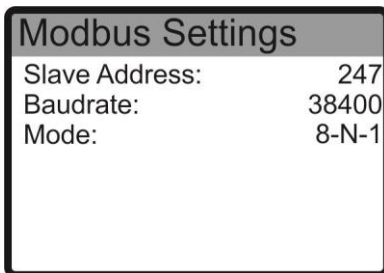

The menu is operated with the keys **[ENT]**, **[ESC]**, **[+]** and **[-]**. Settings can be made as described in section 5.1. **Operating the user menu.**

Further information about the Modbus refer section 6.

Menu item	Description	Possible values
Slave address Slave Adresse	Set the Modbus address for the RS485 interface.	Adjustable from 1 to 247
Baudrate Baudrate	Set the baudrate for the RS485 interface.	4800, 9600, 19'200, 38'400, 57'600, 115'200 Baud
Mode Modus	Set the communication settings for the RS485 interface.	Data: 8bit Parity bit: None, Even, Odd Stopp bit: 1, 2 8-N-1, 8-N-2

5.7. Device info

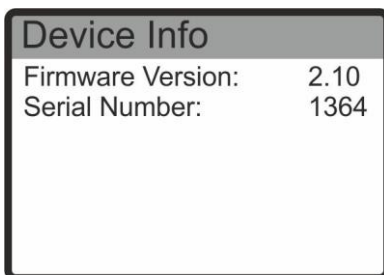

The submenu **Device Info** shows the current firmware version and the serial number of the device.

6. Modbus-RS485

The Display shows the symbol if the device is equipped with an optional Modbus module. The RS485 receive activity is shown as small green box. The device is delivered with a 130 ohm termination resistor. The termination resistor is necessary at the beginning and at the end of a RS485 bus. The device is equipped with a “Failsafe” receiver.

More information about the Modbus implementation refer the document "M3118_M3136_M3329_Modbus_UserGuide_Vx.xx.pdf" on the [Mostec](http://www.mostec.com) website.

7. Wiring

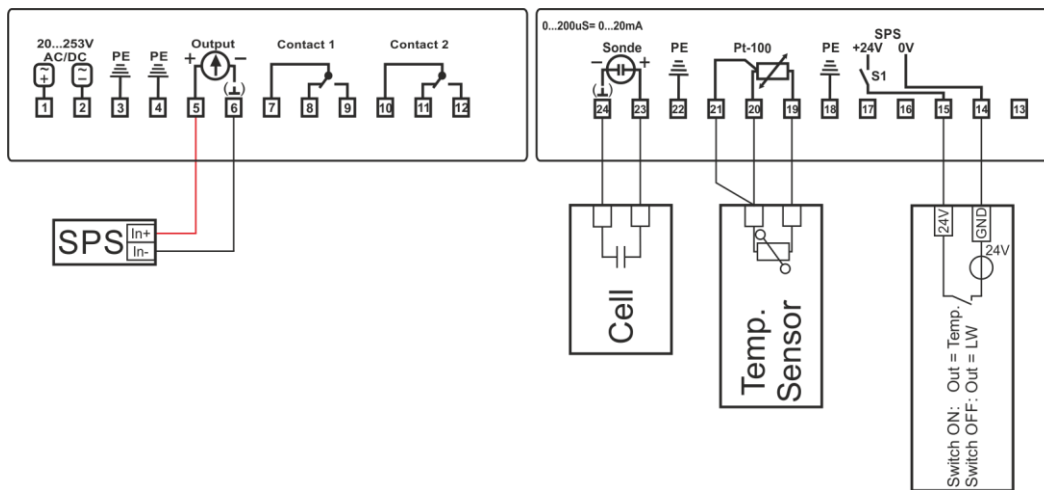

8. Terminals

1	Supply voltage: AC~/DC(+)	9	Alarm contact 1: normally open	17	n.c.
2	Supply voltage: AC~/DC(-)	10	Alarm contact 2: change over	18	Pt-100 sensor: PE
3	Supply voltage: PE	11	Alarm contact 2: normally closed	19	Pt-100 sensor: sensor +
4	Signal output: PE	12	Alarm contact 2: normally open	20	Pt-100 sensor: sensor -
5	Signal output: Signal +	13	n.c.	21	Pt-100 sensor: sensor sense -
6	Signal output: Signal -	14	Switch signal for signal output (0V)	22	Conductivity cell: PE
7	Alarm contact 1: change over	15	Switch signal for signal output (24V)	23	Conductivity cell +
8	Alarm contact 1: normally closed	16	n.c.	24	Conductivity cell -

For Modbus versions:

4	Modbus RS485 – GND	5	Modbus RS485 – A	6	Modbus RS485 – B
---	--------------------	---	------------------	---	------------------

9. Technical Data

Measuring ranges:	0...2.000µS → (K = 0.1, K = 0.01) 0...20.00µS → (K = 10, K = 1.0, K = 0.1, K = 0.01) 0...200.0µS → (K = 10, K = 1.0, K = 0.1, K = 0.01) 0...2.000mS → (K = 10, K = 1.0, K = 0.1) 0...20.00mS → (K = 10, K = 1.0) 0...200.0mS → (K = 10)
Range display:	Displayed on easy to read LCD-Display
Display:	LCD-Display, 4-digit, 15mm height, color adjustable
Accuracy:	0.5%
Reproducibility:	<0.2%
Measuring frequency:	from 80Hz to 10kHz
Measuring amplitude:	70/150mV, conductive cell only
Step response:	Time between an conductivity change from 0% to 100% or reverse measured, between 10% and 90% = 4 seconds
Input protection:	Virtual zero, protected by diodes
Temperature compensation:	Manual from 0°C to 120°C, automatic by an external Pt-100 sensor, 2- or 3-wire connection. The unit calculates with 25°C when the Pt-100 sensor wires are broken.
Temperature slope:	0.00%/°C (without compensation) to 8.00%/°C
Conductivity of water:	The conductivity of water is measured and compensated.
Reference temperature:	25°C
Maximum length of cell cable:	Cable capacity is compensated automatically. The max. capacity must be <10nF.
Alarm contacts:	Two floating change-over contacts may be adjusted over the full range. Each can be defined as normally open or normally closed contact in the menu via the keys.
Status:	on easy to read LCD-Display
Hysteresis:	Adjustable, factory settings is ±5 digit
Contacts rating:	1A with resistiv load / 230VAC
Max. contact load:	100'000 operations at max. load
Max. contact lifecycle:	10'000'000 operations mechanically, without load
Option current output:	Programmable in the range of 0...20mA, galvanically isolated By an external 24V signal, the current output can be switched between conductivity- and temperature measuring. Conductivity measuring (terminal 14 & 15 open): Current output in depending of conductivity measuring Temperature measuring (terminal 14 = 0V, 15 = 24V): Current output in depending of temperature measuring
Max. load:	500Ω
Output impedance:	>1MΩ
Device settings:	Direct on the device, with push keys → see manual
Change options:	measuring ranges, cells K-factor, temperature slope, temperature, limit contacts: operating mode, hysteresis, status
Power supply:	20 to 253VAC or DC
Power supply load:	4.5W to 7.0W at 230VAC
CE-conformity:	Fulfilled
Terminals:	Plug-in screw terminals

Mounting: 35mm mounting rail, EN50022-35

Weight: 200g

Warranty: 2 years

Options:

- User-specified functions
- Conductivity cell type M8836s and M8836si
- USB–logger
- Modbus (without I-Output)