

MOSTEC AG
Elektronische Mess- und Regelsysteme
CH-4410 Liestal, Switzerland
TEL. +41 61 921 40 90
FAX +41 61 921 40 83
Internet: www.mostec.ch
E-Mail: info@mostec.ch



Operating Manual

Conductivity meter

M9836

Warranty:

Mostec warrants this product to be free of manufacturing defects for a 2-year period after the original date of purchase. Within this period, defective products will be repaired free of charge provided that the defect occurred during normal operation. This warranty does not cover damage to the product resulting from ordinary usage such as front panel scratches, broken control elements and corrosion, etc. The customer is responsible for shipping and packing charges for products returned under warranty to Mostec. Mostec warrants this product beyond the 2-year warranty period for an additional 2 years in case of long term damages due to improper manufacturing. Such damages as poorly soldered joints or other assembly problems are also covered by the warranty. Transportation damages are not covered by the warranty and should be referred to the respective delivery service.

Index:	Page
A Typical application	4
B Front panel controls and keyboard	5
C Rear panel controls	6
D How to change the measurement range	7
E How to adjust the limit contacts	8
F How to change the temperature to Pt100	9
G How to change the temperature to manual	10
H How to change the temperature slope %/°C	11
I How to lock/unlock changing the parameters	11
J How to change the cell correction factor	12
K How to change the conductivity cells K-factor	12
L How to change the signal current output	12
M How to invert the limit contacts and lamps	13
N How to change the 2/3-wire Pt-100 sensor	13
O Hold function	14
P Temperature monitoring of the sensor	15
Q Control menu	16/17
R Technical data	18
S Settings factory/customer	19

A. Typical application

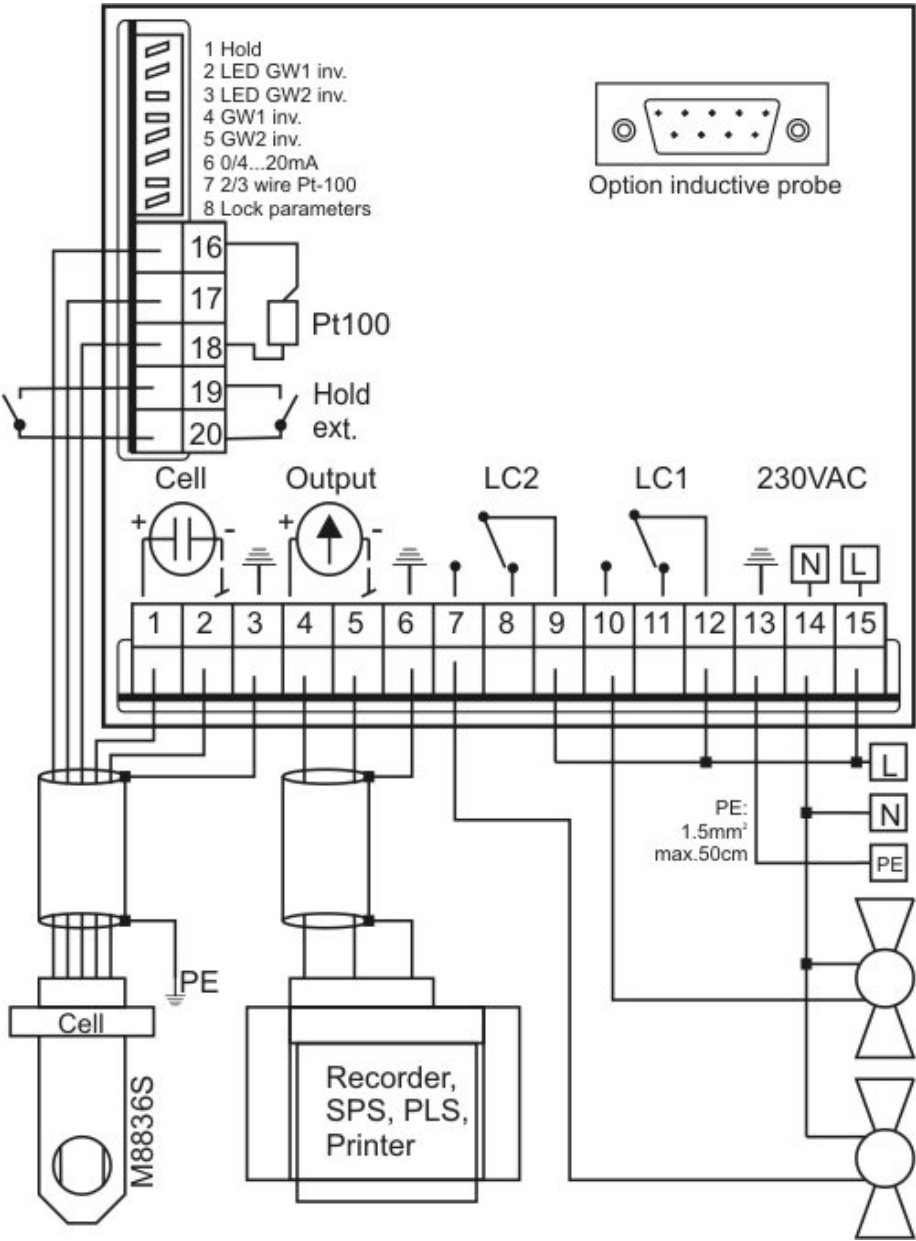

B. Front panel controls and keyboard

No. element	function	description on page
a. Status lamp	limit contact 1.....	9
b. Button	to display/change limit contact 1	9
c. Status lamp	limit contact 2.....	9
d. Button	to display/change limit contact 1	9
e. Status lamp	manual temperature compensation active	10
f. Change over	Pt100/manual temperature compensation	10
g. Status lamp	temperature compensation with Pt100 sensor active	10
h. Button	to display/change temperature slope %/°C	12
i. Button	to display/change temperature.....	11
j. Button	minus, decrease value	9,10,11
k. Button	plus, increase value.....	9,10,11
l. Button	to change the range	7,8
m. Status lamp	automatic range.....	7,8
n. Status lamp	range in mS	7,8
o. Status lamp	range in μ S	7,8



C. Rear panel controls

No. element	function	description on page
1. Switch 1	Hold	14
2. Switch 2	to invert limit contact lamp 1	14
3. Switch 3	to invert limit contact lamp 2	14
4. Switch 4	to invert limit contact 1	14
5. Switch 5	to invert limit contact 2	14
6. Switch 6	signal current output 0...20mA/4...20mA	13
7. Switch 7	2- or 3- wire Pt-100 sensor	14
8. Switch 8	lock/unlock changing the parameters	12

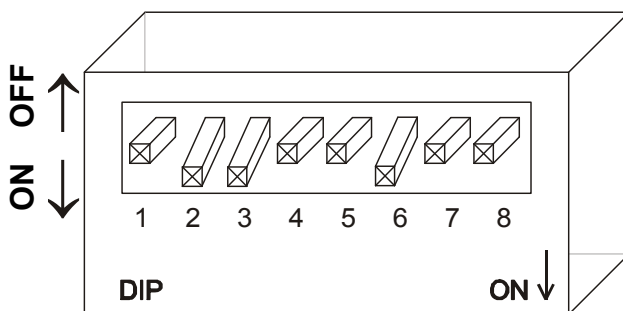

Function switch on side panel:

- Switch 1 On: Hold, actual value = 0
- Switch 1 Off: Hold inactive
- Switch 2 On: inverted limit contact lamp 1
- Switch 2 Off: normal contact lamp 1
- Switch 3 On: inverted limit contact lamp 2
- Switch 3 Off: normal contact lamp 2
- Switch 4 On: inverted limit contact 1
- Switch 4 Off: normal limit contact 1
- Switch 5 On: inverted limit contact 2
- Switch 5 Off: normal limit contact 2
- Switch 6 On: current output 4...20mA
- Switch 6 Off: current output 0...20mA
- Switch 7 On: 2 wire Pt-100 sensor
- Switch 7 Off: 3 wire Pt-100 sensor
- Switch 8 On: lock parameters
- Switch 8 Off: unlock parameters

D. How to change the measurement range

The measurement range can be changed with the button (I.) . 3 green lamps left of the digital display indicate the selected range. The M9836 can be programmed to a manually set range, or to select the range automatically depending on the signal. If the lamp Auto is on, the M9836 selects the best range. If the Auto lamp is off, the range is always the manually set range.

Example 1:

The Instrument is programmed to manual range mS. The displayed value is 0.182mS.





Example 2:

The button (I.)  is pressed one time, the instrument changes the range to μS with the same value: 182.1 μS which is 0.182mS.



Example 3:

Pressing the  key again activates the 0 ... 20 μS range. Since the actual value of 182.1 μS exceeds the range almost by a factor ten, the instrument indicates an Error Message OFL1 (Overflow range 1). This error message can be removed, by pressing the  key until a higher measuring range is selected.



Example Auto:

Push the button (I.)  until the Auto lamp is on. The instrument sets itself to the best range, in our example 182.1 μ S.



Exceeded measuring range

A measuring value greater than the selected measuring range leads to an error message as shown in example 3.

Selected measuring range:	Actual meas. value:	Displayed error message:
0 ... 2 μ S	Signal > 2 μ S	<i>OFL0</i>
0 ... 20 μ S	Signal > 20 μ S	<i>OFL1</i>
0 ... 200 μ S	Signal > 200 μ S	<i>OFL2</i>
0 ... 2mS	Signal > 2mS	<i>OFL3</i>
0 ... 20mS	Signal > 20mS	<i>OFL4</i>
0 ... 200mS	Signal > 200mS	<i>OFL5</i>
0 ... 2S	Signal > 2S	<i>OFL6</i>

E. How to adjust the limit contacts

Both limit contacts are identical and are therefore adjusted in the same way. The status of the limit contacts is indicated by two green lamps (a) and (c).

1. Display the limit value:

- Push and hold one of the limit buttons (b or d).
 - ⇒ The display shows the set value of the corresponding limit contact.
- Note:* While showing the limit contact value, the range lamps (n. or o.) indicates the range where the limit contact is set.

2. Change the limit value:

- Push and hold one of the limit buttons (b or d).
 - ⇒ The display shows the set value of the corresponding limit contact.
- Adjust the requested limit value for this contact with the buttons + (k) or – (j).
- Note:* While showing the limit contact value, the range lamps (n. or o.) indicates the range where the limit contact is set.

3. Change limit contact measurement range:

Example:

- The measurement value is actually at about 3,57mS.
- The needed limit contact value is 5mS.
- The actual limit contact value was programmed to 10.00µS before.
- Push and hold one of the limit buttons (b or d).
- Push the button  (l.). The limit contact value is now automatically 10.00mS.
- Now you can adjust the requested limit value for this contact with the buttons + (k) or – (j).



F. How to change the temperature to Pt100

- Push button Hand/Pt100 (f) until the lamp Pt100 (g) is on.
 - ⇒ The lamps (e) and (g) indicates witch temperature is selected.
 - ⇒ By pushing the button Temp (i) the display shows the actual measured or manually set temperature.

If the M9920 is set to Pt100 and the Pt100 sensor is not connected, damaged, or the temperature is higher than 120°C, the processor internally uses a temperature value of 25°C.



G. How to change the temperature to manual

- Push button Hand/Pt100 (f) until lamp Hand (e) is on.
⇒ The lamps (e) and (g) indicates witch temperature is selected.
- Push and hold button Temp (i).
- ⇒ The display shows the actual manually set temperature.
- Adjust the requested temperature with the buttons + (k) and – (j)



H. How to change the temperature slope %/°C

All liquids have a positive temperature coefficient, expressed in %/°C conductivity change. The higher the temperature the lower the electrical resistance which is equal to higher Siemens values. Water has a slope of about +2.25%/°C.

1. Push and hold the button %/°C (h.).
 ⇒ The display shows the actual value for temperature slope
 (If not, read paragraph I. and remove the parameter lock)
2. Adjust the requested value with the buttons + (k) or – (j).
 The temperature slope is adjusted correctly when conductivity don't change with a change of temperature of the liquid.

Example:

The conductivity is 15.5µS at a temperature of 20°C. Now increase the temperature to 30°C, without chemically changing the medium. The conductivity must still show 15.5µS. When the displayed conductivity value changes, the temperature slope requires readjustment.

Measuring the absolute conductivity at 25°C

You may switch off the temperature compensation by simply selecting slope 0.0%/°C. The values shown are now not temperature compensated.

I. How to lock/unlock changing the parameters

To avoid unintended changes of the instrument parameters, parameter changes can be prevented by setting the switch number 8 to the "on" position. When this switch set to the "on" position, parameters can no longer be changed. Set the switch to the "off" position to change instrument parameters.

Example:

Switch 8	off	parameters unlocked
Switch 8	on	parameters locked

J. How to change the cell correction factor

If the conductivity cell has a special K-factor outside of $K=1.0$, $K=0.1$ and $K=0.01$, the value can be adjusted with the cell correction factor.

Factory set value of K is 1.000. If you have to change this value, the calibration of the M9836 is maintained, but the displayed conductivity value is no longer the standart calibration.

1. Remove the parameter lock described in paragraph I..
2. Push and hold the buttons $\%/\text{°C}$ and Pt-100/manual (f. and h.).
⇒ The display shows the actual value for the cell correction factor K.
3. Adjust the requested value with the buttons + (k) or – (j).

K. How to change the conductivity cells K-factor

The M9836 is factory preprogrammed to four different K-factors with the default setting of $K=1.0$.

Possible cell-K-factors:

C_10 = cell-K-factor 10.0

C_1.0 = cell-K-factor 1.0

C_0.1 = cell-K-factor 0.1

C_.01 = cell-K-factor 0.01

Ind = Inductive probe

After selecting the new K-factor, all impossible ranges are inactive.

1. Remove the parameter lock described in paragraph I..
2. Push and hold the buttons $\%/\text{°C}$ and Pt-100/manual (f. and h.).
⇒ The display shows the actual value for K
3. Push the button ⌂ (l.) until the requested K-factor is displayed.

L. How to change the signal current output

You may select two different output signals with the programming switch on the back panel:

Switch 6	„off“	0...20mA
Switch 6	„on“	4...20mA

The signal current output is always the same for all measurement ranges.

M. How to invert the limit contacts and lamps

On the back panel of the M9836 is a programming switch to set the logic of both, the limit contacts and the corresponding lamps. Both limit contacts are "upper" and identical. By the switch, every limit contact and lamp may be inverted. "Normal" = the lamp and the limit contact are on, when the limit value is exceeded and "inverted" vice versa.

Switch 2	„off“	normal limit contact lamp 1
Switch 3	„off“	normal limit contact lamp 2
Switch 4	„off“	normal limit contact 1
Switch 5	„off“	normal limit contact 2
Switch 2	„on“	inverted limit contact lamp 1
Switch 3	„on“	inverted limit contact lamp 2
Switch 4	„on“	inverted limit contact 1
Switch 5	„on“	inverted limit contact 2

N. How to change the 2/3-wire Pt-100 sensor

On the back panel of the M9836 is a programming switch to set the Pt-100 sensors connection. The temperature has a big influence to the measured conductivity. A 3-wire connection of the Pt-100 is recommended or required for best conductivity measurements. To be compatible to older models, you may also setup a 2 wire Pt-100 sensor connection.

Switch 7	„off“	3 wire Pt-100
Switch 7	„on“	2 wire Pt-100

O. Hold function

The instrument can be set either internally or externally to ‚HoLd‘. Doing so, the display indicates the Text ‚HoLd‘. The internal actual value is set to 0.0. Both limit contacts and the current source act as if the measuring value would be 0.0. This function is useful to suppress alarm conditions of the system while performing flushing or regeneration processes.

Switch 1	„off“	normal function
Switch 1	„on“	‚HoLd‘ condition
Clamp Ext. Hold	„open“	normal function
Clamp Ext. Hold	„bridged“	‚HoLd‘ condition

P. Temperature monitoring of the sensor

This function monitors the temperature of the conductivity cell and activates limit contact 2, when the temperature exceeds the adjusted temperature of the limit contact 2. With this function, over temperature in the system can be avoided.

1. Display / change of the temperature

First, remove the parameter lock described in paragraph I.. The temperature monitoring temperature can be adjusted in the control under the item *SE_T*, see paragraph Q.

2. Activate / deactivate the temperature monitoring function.

First, remove the parameter lock described in paragraph I.. The temperature monitoring function can be set in the control menu under the item *SENS*, see paragraph Q.

Limit contact 2 is used for temperature monitoring. If the function is active, limit contact 2 can no longer be adjusted as limit contact 1. The display indicates *SENS* when the limit contact 2 is pressed.

Q. Control menu

Software version 1.09 and later contains a control menu. This menu is not necessary for normal use. It contains some special functions as well as some already known parameters which can be adjusted in this menu.

Handling:

Access to the menu: press both buttons (+) and (-) for 0.5 sec.
 Navigation within the menu: buttons (+) and (-)
 Access to a menu item: button (↵) (= ENTER)
 Leave a menu item: button (Temp.) (= ESCAPE)
 Adjust values: button (+) and (-)

(+) & (-)

↓

→ CELL

(↵)→

←(Temp.)/(↵) C_1.0 ↓ (+)

** * C_0.1 ↓ (+)

C_0.01 ↓ (+)

C_10 ↓ (+)

IND ↓ (+)

↓ (+) / ↑ (-)

→ ADST

(↵)→

(+)/(-)

←(Temp.)/(↵) 1.000

↓ (+) / ↑ (-)

→ SE_T

(↵)→

(+)/(-)

←(Temp.)/(↵) 15.0

↓ (+) / ↑ (-)

→ SENS

(↵)→

(+)/(-)

←(Temp.)/(↵) ON OFF

↓ (+) / ↑ (-)

→ CURR

(↵)→

(+)/(-)

←(Temp.)/(↵) 2.000 + Led μS ↓ (+) / ↑ (-)

20.00 + Led μS ↓ (+) / ↑ (-)

200.0 + Led μS ↓ (+) / ↑ (-)

2.000 + Led mS ↓ (+) / ↑ (-)

20.00 + Led mS ↓ (+) / ↑ (-)

200.0 + Led mS ↓ (+) / ↑ (-)

2.000 + Led μS&mS = S ↓ (+) / ↑ (-)

AUTO + Led Auto ↓ (+) / ↑ (-)

↓ (+) / ↑ (-)

→ DET_

(↵)→

(+)/(-)

←(Temp.)/(↵) ON OFF

** Quit menu, without storing the display values

* Quit menu, storing the display values

<i>CELL</i>	Select the cell k-factor
<i>IND</i>	Inductive conductivity cell
<i>ADST</i>	Adjust the cell correction factor. (Factory setting = 1.0)
<i>SE_T</i>	Adjust the probe temperature monitoring temperature.
<i>SENS</i>	Activate / deactivate the probe temperature monitoring
<i>CURR</i>	Define the signal current range. Auto = Signal current range is defined for the current measuring range. (Factory setting = auto)

Example 1:

CURR Setting = Auto, Meas. Range = 20.00 μ S,
 Switch 6 = "off" (0 ... 20mA)
 Conductivity = 10.00 μ S \rightarrow Signal Current = 10.00mA
 After switching to 200.0 μ S Measuring Range
 Conductivity = 10.00 μ S \rightarrow Signal Current = 1.00mA
 After switching to 2.000mS Measuring Range
 Conductivity = 10.00 μ S \rightarrow Signal Current = 0.10mA

Example 2:

CURR Setting = 20.00 μ S, Meas. Range = 20.00 μ S,
 Switch 6 = "off" (0 ... 20mA)
 Conductivity = 10.00 μ S \rightarrow Signal Current = 10.00mA
 After switching to 200.0 μ S Measuring Range
 Conductivity = 10.00 μ S \rightarrow Signal Current = 10.00mA
 After switching to 2.000mS Measuring Range
 Conductivity = 10.00 μ S \rightarrow Signal Current = 10.00mA

<i>DET_</i>	Activate / deactivate the wire break detection of the conductivity cell. The wire break error <i>ERR1</i> is activated, if the actual measuring signal undershoots the value of 0.5% full scale. In this case the display shows the value <i>ERR1</i> , the current output is set to >21mA and both limit contacts are activated.
-------------	--



R. Technical data

Technical Data:

Measuring ranges:	0 ..2 000µS	<=0.1, K=0.01
	0 ..20.00µS	<=1.0, K=0.1, <=0.01
	0 ..200.0µS	<=1.0, K=0.1, <=0.01
	0 ..2 000mS	<=1.0, K=0.1, inductive cell
	0 ..20.00mS	<=1.0, inductive cell
	0 ..200.0mS	<=1.0, inductive cell
	0 ..2 000S	inductive cell

Range indicators: 3 green lamps
 Display: Red LED-display 3 1/2-digit, character high 12.7mm
 Accuracy: 0.5%

Measuring frequency: 60Hz ..10kHz
 Measuring amplitude: 70mV and 150mV, conductive cell only
 Step response: Time between a conductivity change from 0% to 100% or reverse measured between 10% and 90% = 4 seconds.

Temperature compensation: manual from 0 to 120°C.
 automatic by an external Pt-100 platinum by 2 or 3 wire. The unit calculates with 25°C when the Pt-100 sensor wires are broken.

Temperature slope: 0.00%/°C (=without compensation) to 8.00%/°C.
 Conductivity of water: Is measured and temperature compensated.
 Reference temperature: 25°C

Maximum length of cell cable: Cable capacity is compensated automatically. The max. capacity must be <0.02µF

Limit or alarm contacts: two floating change-over contacts can be adjusted over the full range. Each can be defined as a normally open or normally closed contact by an internal slide switch.

Adjustment of the limit contacts: each limit value can be adjusted by a button on the front panel. The limit value is displayed by pressing the corresponding button and can be changed with the + or - button over the full measuring range.

Range selection: LED lamps left of the display indicates the selected range where the limit contacts are active!
 Status: the limit status is indicated by two green lamps
 Hysteresis: 10 parts fixed

Contacts rating: change over at 6A/230VAC with resistive load
 Contact life: 200'000 operations at max. load
 Output current signal: 0 .. 20mA or 4 .. 20mA over the selected range.
 0 ..20mA or 4 ..20mA can be defined by an internal slide switch which is accessible to the user.
 The output signal is galvanically isolated.

Output impedance: >1MΩ at 20mA
 Maximum load: >500Ω
 Supply voltage: 230V/50-60Hz, ca. 8VA
 Operating temperature: -25...+70°C
 CE-Conformity: fulfilled
 Case: black plastic case 96x96 mm, aluminium shielded
 Mounting: 2 mounting clamps
 Terminals: 2 plug-in screw terminals for supply, limit contacts and signals

Terminal description:	
1 - Conductivity cell +	10 - Limit contact 1 norm. open
2 = Conductivity cell -	11 = Limit contact 1 norm. closed
3 - Conductivity cell PE	12 - Limit contact 2 change over
4 = Output current signal +	13 = Protective earth PE
5 = Output current signal -	14 = Supply voltage N
6 - Output current signal PE	15 = Supply voltage L1
7 = Limit contact 2 norm. open	16 = Pt-100 platinum sensor wire 1
8 = Limit contact 2 norm. closed	17 = Pt-100 platinum sensor sense
9 = Limit contact 2 change over	18 = Pt-100 platinum sensor wire 2

Weight: 800 grams (28 ounces)
 Warranty: 2 years
 How to order: M9836-X

Options:
 -leak proof housing IP54
 -different cell constants
 -cell: M8836s (0.01, 0 and 10 conductive)
 M8836si (inductive)

Typical application:

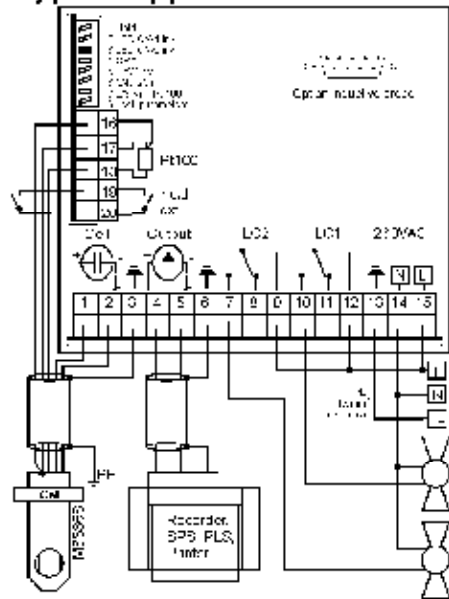

Dimensions:

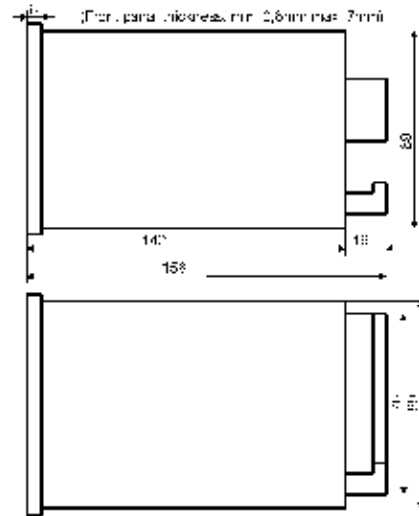

Cut out dimensions:

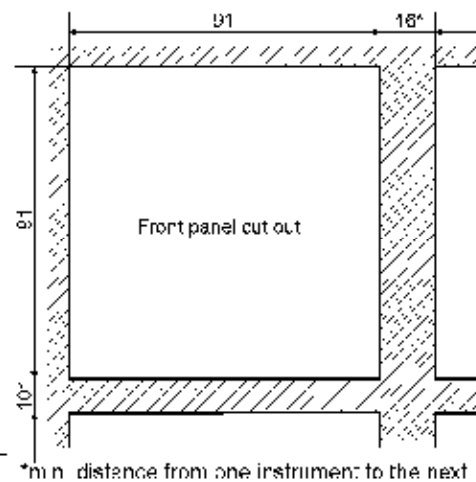

S. Setting		factory	customers
<i>CELL</i>	Cell k-factor	<i>C_1.0</i>	<input type="text"/>
<i>ADST</i>	Cell correction factor	<i>1.000</i>	<input type="text"/>
<i>SE_T</i>	Probe temp. monitoring temp.	<i>25.0</i>	<input type="text"/>
<i>SENS</i>	Probe temp. monitoring	<i>OFF</i>	<input type="text"/>
<i>CURR</i>	Signal current range	<i>AUTO</i>	<input type="text"/>
<i>DET_</i>	Break detection	<i>OFF</i>	<input type="text"/>
<i>FRONT</i>	Limit contact 1	<i>10.00</i> μ S	<input type="text"/>
<i>FRONT</i>	Limit contact 2	<i>10.00</i> μ S	<input type="text"/>
<i>FRONT</i>	manual temperature	<i>25.0</i>	<input type="text"/>
<i>FRONT</i>	temperature slope	<i>2.25</i>	<input type="text"/>
<i>FRONT</i>	Measuring range	<i>AUTO</i>	<input type="text"/>
<i>BACK</i>	Switch 1 Hold	<i>OFF</i>	<input type="text"/>
<i>BACK</i>	Switch 2 invert. limit con. -lamp 1	<i>OFF</i>	<input type="text"/>
<i>BACK</i>	Switch 3 invert. limit con. -lamp 2	<i>OFF</i>	<input type="text"/>
<i>BACK</i>	Switch 4 inverted limit contact 1	<i>OFF</i>	<input type="text"/>
<i>BACK</i>	Switch 5 inverted limit contact 2	<i>OFF</i>	<input type="text"/>
<i>BACK</i>	Switch 6 signal output 4-20	<i>OFF</i>	<input type="text"/>
<i>BACK</i>	Switch 7 2-wire PT-100	<i>OFF</i>	<input type="text"/>
<i>BACK</i>	Switch 8 lock parameters	<i>OFF</i>	<input type="text"/>

